

Free Flow Unslotted Waste

ILLUSTRATED

E2114 Free flow unslotted waste with ceramic cover

ILLUSTRATED PRODUCT DETAILS

Weights

E2114 0.33 KG













Finishes

E2114  White (01)

Materials

E2114 Mixed Material

FINISH OPTIONS

		
(01) White	(V1) Silk White	(V2) Black Glossy
		
(V3) Black Matt	(V4) Kashmir	(V5) Slate Grey
		
(V6) Pomegranate	(V7) Nude	(V8) Mink
		
(V9) Concrete	(X8) Powder	(X9) Sage

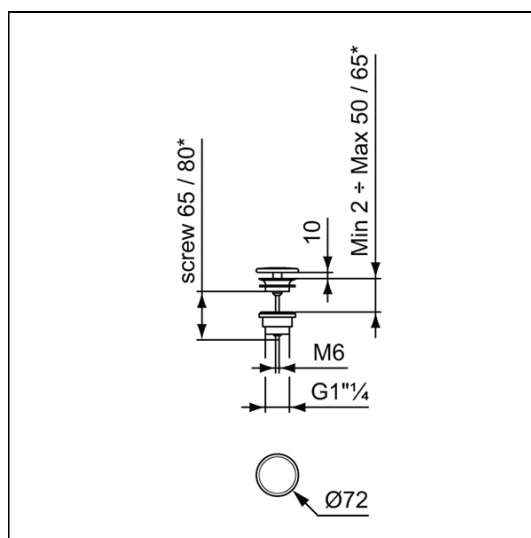

Free Flow Unslotted Waste

